

# GB2R User Guide

 **МУЗЦЕНТР**  
МУЗЫКАЛЬНОЕ ОБОРУДОВАНИЕ  
<https://muzcentre.ru/>





### IMPORTANT

Please read this manual carefully before using  
your mixer for the first time.



This equipment complies  
with the EMC Directive  
2004/108/EC and  
LVD 2006/95/EC

This product is approved to  
safety standards:

IEC 60065: 2001  
EN60065:2002  
UL6500 7th Edition: 2003  
CAN/CSA-E60065-03

And EMC standards  
EN55103-1: 1996 (E2)  
EN55103-2: 1996 (E2)

**For further details contact:**

Harman International Industries Ltd.  
Cranborne House, Cranborne Road  
Potters Bar, Hertfordshire, EN6 3JN, UK

Tel: +44 (0) 1707 665000  
Fax: +44 (0) 1707 660742  
e-mail: [info@soundcraft.com](mailto:info@soundcraft.com)

© Harman International Industries Ltd. 2007

All rights reserved

Parts of the design of this product may be protected by worldwide patents.

Part No. ZM0351-01 Rev. B

Soundcraft is a trading division of Harman International Industries Ltd. Information in this manual is subject to change without notice and does not represent a commitment on the part of the vendor. Soundcraft shall not be liable for any loss or damage whatsoever arising from the use of information or any error contained in this manual.

No part of this manual may be reproduced, stored in a retrieval system, or transmitted, in any form or by any means, electronic, electrical, mechanical, optical, chemical, including photocopying and recording, for any purpose without the express written permission of Soundcraft.



Harman International Industries Limited

Cranborne House

Cranborne Road

POTTERS BAR

Hertfordshire

EN6 3JN

UK

Tel: +44 (0)1707 665000

Fax: +44 (0)1707 660742

<http://www.soundcraft.com>

# Contents

IMPORTANT SAFETY INSTRUCTIONS	4
SAFETY SYMBOL GUIDE	6
<b>Installation</b>	<b>7</b>
MAINS INSTALLATION	7
WORKING SAFELY WITH SOUND	9
Audio Connector Pinouts	12
<b>Introduction</b>	<b>13</b>
Key Features	14
Warranty	15
<b>Block Diagrams</b>	<b>16</b>
Input Channels	16
Master Section / Outputs	17
<b>Using The Console</b>	<b>18</b>
Mono Input	19
Stereo Input - GB2R 12-2 only	20
Master Section	23
Front Panel Connectors	24
Rear Connector Panel	25
<b>Typical Specifications</b>	<b>27</b>
<b>GB2R 12/2 Mark-up Sheet</b>	<b>28</b>
<b>GB2R 16 Mark-up Sheet</b>	<b>30</b>
<b>Dimensions</b>	<b>32</b>
<b>Rack Mounting</b>	<b>33</b>

## IMPORTANT SAFETY INSTRUCTIONS

Read these instructions.

Keep these instructions.

Heed all warnings.

Follow all instructions.

Do not use this apparatus near water.

Clean only with a dry cloth.

Do not block any ventilation openings. Install in accordance with the manufacturer's instructions.

Do not install near any heat sources such as radiators, heat registers, stoves, or other apparatus (including amplifiers) that produce heat.

Do not defeat the safety purpose of a polarised or grounding type plug. A polarised plug has two blades with one wider than the other. A grounding type plug has two blades and a third grounding prong. The wide blade or the third prong are provided for your safety. If the provided plug does not fit into your outlet, consult only a Qualified and Approved Electrician for replacement of the obsolete outlet.

Protect the power cord from being walked on or pinched particularly at plugs, convenience receptacles and the point where they exit from the apparatus.

Only use attachments/accessories specified by the manufacturer.



Use only with the cart, stand, tripod, bracket or table specified by the manufacturer, or sold with the apparatus. When a cart is used, use caution when moving the cart/apparatus combination to avoid injury from tip-over.

Unplug this apparatus during lightning storms or when unused for long periods of time.

Refer all servicing to qualified service personnel. Servicing is required when the apparatus has been damaged in any way, such as power-supply cord or plug is damaged, liquid has been spilled or objects fallen into the apparatus, the apparatus has been exposed to rain or moisture, does not operate normally, or has been dropped.

Note: It is recommended that all maintenance and service on the product should be carried out by Soundcraft or its authorised agents. Soundcraft cannot accept any liability whatsoever for any loss or damage caused by service, maintenance or repair by unauthorised personnel.

**WARNING:** To reduce the risk of fire or electric shock, do not expose this apparatus to rain or moisture. Do not expose the apparatus to dripping or splashing and do not place objects filled with liquids, such as vases, on the apparatus.

No naked flame sources, such as lighted candles, should be placed on the apparatus.

Warning: Do not use this apparatus in very dusty atmospheres, or in atmospheres containing flammable gases or chemicals.

**THIS APPARATUS MUST BE EARTHED.** Under no circumstances should the safety earth be disconnected from the mains lead.

The mains supply disconnect device is the mains plug. It must remain accessible so as to be readily operable when the apparatus is in use.

If any part of the mains cord set is damaged, the complete cord set should be replaced. The following information is for reference only.

The wires in the mains lead are coloured in accordance with the following code:

Earth (Ground): Green and Yellow (US - Green/Yellow)

Neutral: Blue (US - White)

Live (Hot): Brown (US - Black)

As the colours of the wires in the mains lead may not correspond with the coloured markings identifying the terminals in your plug, proceed as follows:

The wire which is coloured Green and Yellow must be connected to the terminal in the plug which is marked with the letter E or by the earth symbol. 

The wire which is coloured Blue must be connected to the terminal in the plug which is marked with the letter N

The wire which is coloured Brown must be connected to the terminal in the plug which is marked with the letter L

Ensure that these colour codes are followed carefully in the event of the plug being changed

This unit is capable of operating over a range of mains voltages as marked on the rear panel.

**NOTE:** This equipment has been tested and found to comply with the limits for a Class A digital device, pursuant to Part 15 of the FCC Rules. These limits are designed to provide reasonable protection against harmful interference when the equipment is operated in a commercial environment. This equipment generates, uses and can radiate radio frequency energy and, if not installed and used in accordance with the instruction manual, may cause harmful interference to radio communications. Operation of this equipment in a residential area is likely to cause harmful interference in which case the user will be required to correct the interference at his own expense.

This Class A digital apparatus meets the requirements of the Canadian Interference-Causing Equipment Regulations.

Cet appareil numérique de la Classe A respecte toutes les exigences du Règlement sur le matériel brouilleur du Canada.

**For your own safety and to avoid invalidation of the warranty please read this section carefully.**

## **SAFETY SYMBOL GUIDE**

For your own safety and to avoid invalidation of the warranty all text marked with these symbols should be read carefully.



### **WARNINGS**

**The lightning flash with arrowhead symbol, is intended to alert the user to the presence of un-insulated “dangerous voltage” within the product’s enclosure that may be of sufficient magnitude to constitute a risk of electric shock to persons.**



### **CAUTIONS**

**The exclamation point within an equilateral triangle is intended to alert the user to the presence of important operating and maintenance (servicing) instructions in the literature accompanying the appliance.**



### **NOTES**

**Contain important information and useful tips on the operation of your equipment.**



### **HEADPHONES SAFETY WARNING**

**Contain important information and useful tips on headphone outputs and monitoring levels.**

# Installation

## General Precautions

Avoid storing or using the mixing console in conditions of excessive heat or cold, or in positions where it is likely to be subject to vibration, dust or moisture. Do not use any liquids to clean the fascia of the unit: a soft dry cloth is ideal.

Avoid using the console close to strong sources of electromagnetic radiation (e.g. video monitors, high-power electric cabling): this may cause degradation of the audio quality due to induced voltages in connecting leads and chassis.

**Caution! In all cases, refer servicing to qualified personnel.**

## Handling and Transport

The console is supplied in a strong carton. If it is necessary to move it any distance after installation it is recommended that this packing is used to protect it. Be sure to disconnect all cabling before moving. If the console is to be regularly moved we recommend that it is installed in a foam lined flightcase. At all times avoid applying excessive force to any knobs, switches or connectors.

## Power Cable

Always use the power supply cable supplied with the mixer: the use of alternative cables may cause damage and voids the warranty.

**Warning! In the event of an electrical storm, or large mains voltage fluctuations, immediately switch off the mixer and unplug from the mains.**

## Signal Levels

It is important to supply the correct input levels to the console, otherwise signal to noise ratio or distortion performance may be degraded; and in extreme cases, damage to the internal) circuitry may result. Likewise, on all balanced inputs avoid sources with large common mode DC, AC or RF voltages, as these will reduce the available signal range on the inputs. Note that  $OdBu = 0.775V$  RMS. Refer to the Specifications section for details of input and output levels.

## MAINS INSTALLATION

### General Wiring Procedures

To take full advantage of the excellent signal to noise ratio and low distortion of Soundcraft consoles, care must be taken to ensure that incorrect installation and wiring does not degrade the performance of the desk. Hum, buzz, instability and Radio Frequency interference can usually be traced to earth loops and inferior earthing systems. In some areas, especially heavily industrial areas, the incoming mains earth will not be adequate and a separate technical earth for all the audio equipment must be supplied. However, check with your local electricity supply company to ensure that safety regulations are not infringed or negated.

The successful, hum free, installation of a system requires forethought, and the establishment of a set of ground rules, which must be consistently adhered to at all stages of installation.

## Initial Wiring Considerations

For optimum performance, it is essential for the earthing system to be clean and noise free, as all signals are referenced to this earth. A central point should be decided on for the main earth point system, and all earths should be 'star fed' from this point. It is common electrical practice to 'daisy chain' the earths to all electrical outlets but this method is unsuitable for audio installations. The preferred method is to run an individual earth wire from each outlet, back to the system star point to provide a safety earth screen reference for each piece of equipment. A separate earth wire should also be run from each equipment rack and area, to the star point. This may or may not be used depending on circumstances, but it is easier to install in the first place, than later when problems arise. The location of the star point should be a convenient, easily accessible place, preferably at the rear of the console or in the main equipment rack.

Install separate 'clean' and 'dirty' mains outlets, wired individually back to the incoming mains distribution box. Use the 'clean' supply for all audio equipment and the 'dirty' supply for all lighting, etc. Never mix the two systems.

If necessary, to provide sufficient isolation from mains borne interference, install an isolating transformer. This should be provided with a Faraday Shield which must be connected with earth.

Never locate the incoming mains distribution box near audio equipment, especially tape recorders, which are very sensitive to electro-magnetic fields.

Ensure that all equipment racks are connected to earth, via a separate wire back to the star point.

Equipment which has unbalanced inputs and outputs may need to be isolated from the rack to prevent earth loops.

## Audio Wiring

Having provided all equipment with power and earthing connections, consideration must be given to the method of providing audio interconnection and adequate screening of those interconnections. This must be done in a logical sequence to avoid problems and assist in the localisation of problem equipment.

Connect the FOH or Monitor system to the console and check for any hum, buzz, or RFI. Only when you are satisfied with the quietness of the console and the PA system should you proceed with the next step.

Connect stereo or multitrack tape recorders, FX and foldback sends one at a time, checking and isolating any connection which degrades performance.

Connect all other peripheral devices.

Connect all microphone lines.

By following this sequence much time and future trouble will be saved, and the result will be a quiet, stable system.

## Shielding

Audio equipment is supplied with a variety of input and output configurations, which must be taken into consideration when deciding where the screen connections should be made. There are three sources of unwanted signal being impressed on the screen, which are as follows:

Extraneous electrostatic or electromagnetic fields.

Noise and interference on the earth line.

Capacitive coupling between the screen and signal wires.

To minimise the adverse affects of the unwanted coupling to the signal wires, it is important that the screen is connected at one end only, i.e. the screen must not carry any signal current. Any signal on the wires within the screen will be capacitively coupled to the screen. This current will ultimately be returned to the source of the signal, either directly, if the screen is connected at the signal source end, or indirectly via the earthing system, if the signal is connected at the signal destination end. The indirect connection will cause an increase in high frequency cross-talk, and should be avoided wherever possible.

Therefore, in general, always connect the shield only at the signal source end. In high RF areas, the screen can also be connected to earth via a 0.01 mF capacitor. This will present a short circuit at RF frequencies, thus lowering the effective shield impedance to ground. However, at low audio frequencies the reactance of the capacitor will be sufficiently high not to cause an earth loop problem.



## Points to Remember

In all cases, use good quality twin screened audio cable. Check for instability at the output. Always connect both conductors at both ends, and ensure that the screen is only connected at one end. Do not disconnect the mains earth from each piece of equipment. This is needed to provide both safety and screen returns to the system star point. Equipment which has balanced inputs and outputs may need to be electrically isolated from the equipment rack and/or other equipment, to avoid earth loops. It is important to remember that all equipment which is connected to the mains is a potential source of hum and interference and may radiate both electrostatic or electromagnetic radiation. In addition, the mains will also act as a carrier for many forms of RF interference generated by electric motors, air-conditioning units, thyristor light dimmers etc. Unless the earth system is clean, all attempts to improve hum noise levels will be futile. In extreme cases there will be no alternative but to provide a completely separate and independent 'technical earth' to replace the incoming 'noisy earth'. However, always consult your local electricity supply authority to ensure that safety regulations are not being infringed.



## WORKING SAFELY WITH SOUND

Although your new console will not make any noise until you feed it signals, it has the capability to produce sounds which when monitored through an amplifier or headphones can damage hearing over time. The table below is taken from the Occupational Safety & Health Administration directive on Occupational noise exposure (1926.52):

### PERMISSABLE NOISE EXPOSURE

DURATION PER DAY, HOURS	SOUND LEVEL dBA SLOW RESPONSE
8	90
6	92
4	95
3	97
2	100
1.5	102
1	105
0.5	110
<0.25	115

Conforming to this directive will minimise the risk of hearing damage caused by long listening periods. A simple rule to follow is the longer you listen the lower the average volume should be.

Please take care when working with your audio - if you are manipulating controls which you don't understand (which we all do when we are learning), make sure your monitors are turned down. Remember that your ears are the most important tool of your trade, look after them, and they will look after you.

Most importantly - don't be afraid to experiment to find out how each parameter affects the sound - this will extend your creativity and help you to get the best results.

**Recommended headphone impedance is 50-600 ohms.**

## Setting Up & Troubleshooting

### Initial set-up

Once you have connected up your system (see the sections on connection and wiring earlier in this manual for guidance) you are ready to set initial positions for the controls on your mixer.

Set up individual input channel as follows:

Connect your sources (microphone, keyboard etc.) to the required inputs and release the MUTE switches. Note: Phantom powered mics should be connected before the 48V is switched on.

Set Master faders at 0, input faders at 0, route the channels to MIX and set power amplifier level to suit the application.

Provide a typical performance level signal and press the PFL button on the first channel, monitoring the level on the bargraph meters.

Adjust the input gain until the meter display is in the amber section, with occasional peaks to the first red LED at a typical maximum source level. This allows sufficient headroom to accommodate peaks and establishes the maximum level for normal operation (but see note below).

Repeat this procedure on other channels as required.

Listen carefully for the characteristic sound of `feedback'. If you cannot achieve satisfactory input level setting without feedback, check microphone and speaker placement and repeat the exercise. If feedback persists, it may be necessary to use a Graphic Equaliser to reduce the system response at particular resonant frequencies.

Note: The initial settings should only be regarded as a starting point for your mix. It is important to remember that many factors affect the sound during a live performance, for instance the channel EQ settings or even the size of the audience!

You are now ready to start building the mix and this should be done progressively, listening carefully for each component in the mix and watching the meters for any hint of overload. If this occurs, back off the appropriate Channel Fader slightly until the level is out of the red segments, or adjust the Mix Master Faders. This procedure will ensure that the mixer is set up correctly, with adequate headroom. If more amplification is needed, adjust the power amplifier level controls.

### Troubleshooting

#### No Power

Is the mains supply present?

Is the mains lead firmly connected?

Check the mains fusing

If only one of the power indicators is illuminated, consult your Soundcraft dealer

#### Condenser Mic Not Working

Is the 48V turned on?

Is the mic plugged into the Mic input?

Is the mic cable a balanced 3-wire type?

**Meters not showing any signal**

Has the input gain been set correctly? (see above.)

Is the source connected to the appropriate input socket for the level of signal?

Do you have something connected on the Inserts, and is that external device switched on?

Are the Master faders set at max., are input faders set high enough and is the channel routed to the output being monitored?

Is the MUTE switch released on the relevant channels?

Is the appropriate monitor select switch pressed?

Is there a PFL/AFL pressed on another channel?

**No Mix output**

Check that the Mix Master Fader is up?

**No Monitor output**

Are the Monitor + Phones controls set high enough?

Is the appropriate monitor select switch pressed?

**Headphones Distorting**

Are the headphones less than 50Ω impedance?

Is the Phones level set too high?



## Audio Connector Pinouts

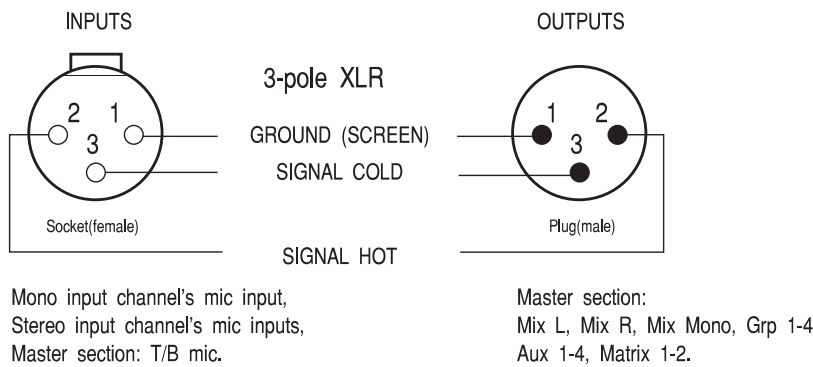

### 1/4" Stereo Jack Plug used as balanced Input/Output:

**All Jacks except headphones and insert points as listed below.**

Mono Input Channel: Line Input, Direct Output.

Stereo Input Channel: Line Inputs Left & Right.

Master Section: Left & Right Monitor Outputs, Aux 5-6 Outputs.

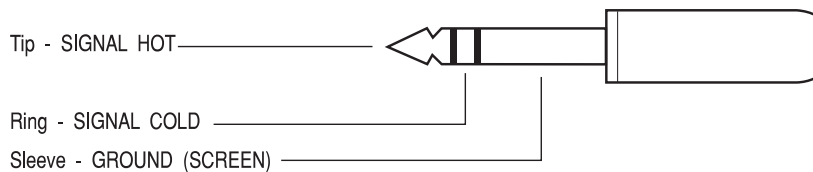

### 1/4" Stereo Jack Plug used for Headphones

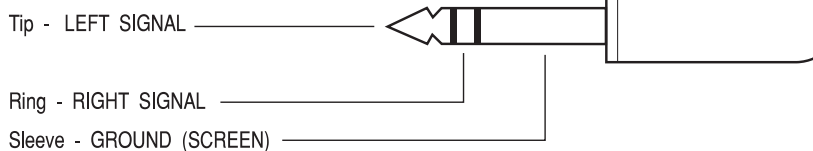

### 1/4" Stereo Jack Plug used for Insert Point as listed below:

Mono Input, Mix L, Mix R, Group 1-4.

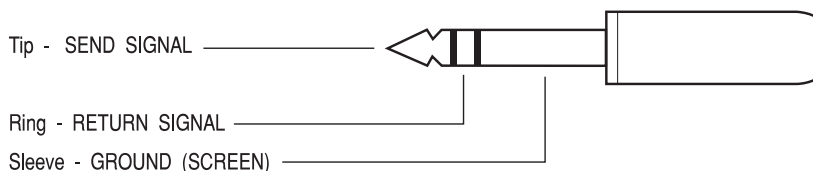

### RCA Phono Plug used as listed below:

Record Out L & R, 2-Track In L & R.

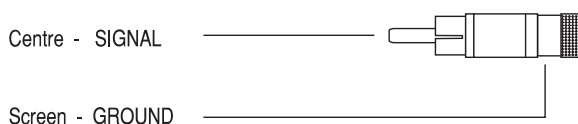

# Introduction

## **Key Features**

**Thank you for buying a GB2R 12/2 or GB2R 16 mixing console, the main features are:**

**Individually switched 48V phantom power on every mono input module.**

**6 Aux sends.**

**2 Sub-group sends (paired) (GB2R 12/2 only).**

**GB30 mic pre-amp.**

**4-band GB30 EQ.**

**Integral power supply.**

**All metal TRS jacks and Neutrik XLRs.**

**Direct outputs on all mono input channels.**

**Rack-mountable.**

## Warranty

- 1 Soundcraft is a trading division of Harman International Industries Ltd. End User means the person who first puts the equipment into regular operation.  
Dealer means the person other than Soundcraft (if any) from whom the End User purchased the Equipment, provided such a person is authorised for this purpose by Soundcraft or its accredited Distributor. Equipment means the equipment supplied with this manual.
- 2 If within the period of twelve months from the date of delivery of the Equipment to the End User it shall prove defective by reason only of faulty materials and/or workmanship to such an extent that the effectiveness and/or usability thereof is materially affected the Equipment or the defective component should be returned to the Dealer or to Soundcraft and subject to the following conditions the Dealer or Soundcraft will repair or replace the defective components. Any components replaced will become the property of Soundcraft.
- 3 Any Equipment or component returned will be at the risk of the End User whilst in transit (both to and from the Dealer or Soundcraft) and postage must be prepaid.
- 4 This warranty shall only be available if:
  - a) the Equipment has been properly installed in accordance with instructions contained in Soundcraft's manual; and
  - b) the End User has notified Soundcraft or the Dealer within 14 days of the defect appearing; and
  - c) no persons other than authorised representatives of Soundcraft or the Dealer have effected any replacement of parts maintenance adjustments or repairs to the Equipment; and
  - d) the End User has used the Equipment only for such purposes as Soundcraft recommends, with only such operating supplies as meet Soundcraft's specifications and otherwise in all respects in accordance Soundcraft's recommendations.
- 5 Defects arising as a result of the following are not covered by this Warranty: faulty or negligent handling, chemical or electro-chemical or electrical influences, accidental damage, Acts of God, neglect, deficiency in electrical power, air-conditioning or humidity control.
6. The benefit of this Warranty may not be assigned by the End User.
7. End Users who are consumers should note their rights under this Warranty are in addition to and do not affect any other rights to which they may be entitled against the seller of the Equipment.

# Block Diagrams

## Input Channels

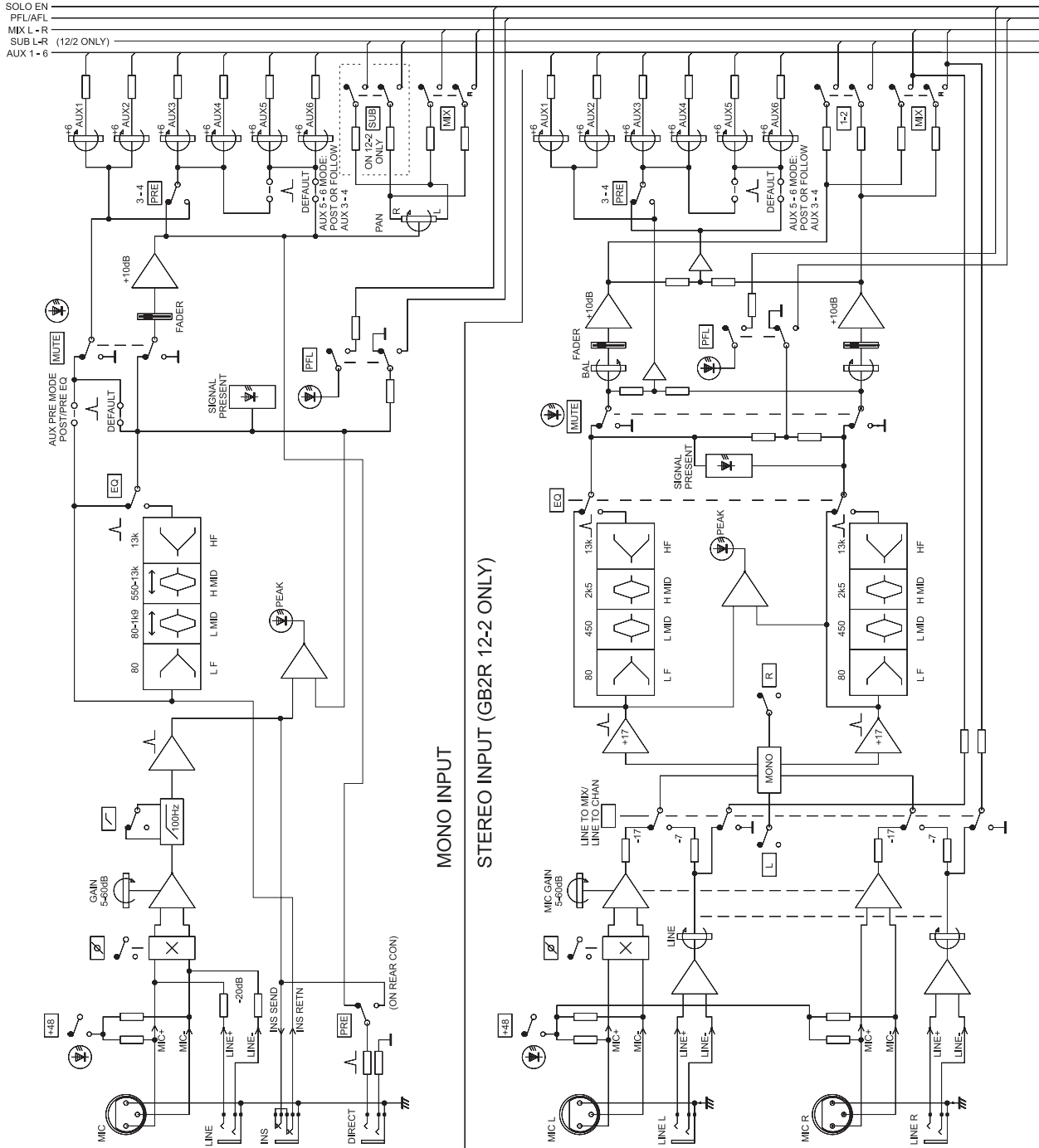



# Master Section / Outputs

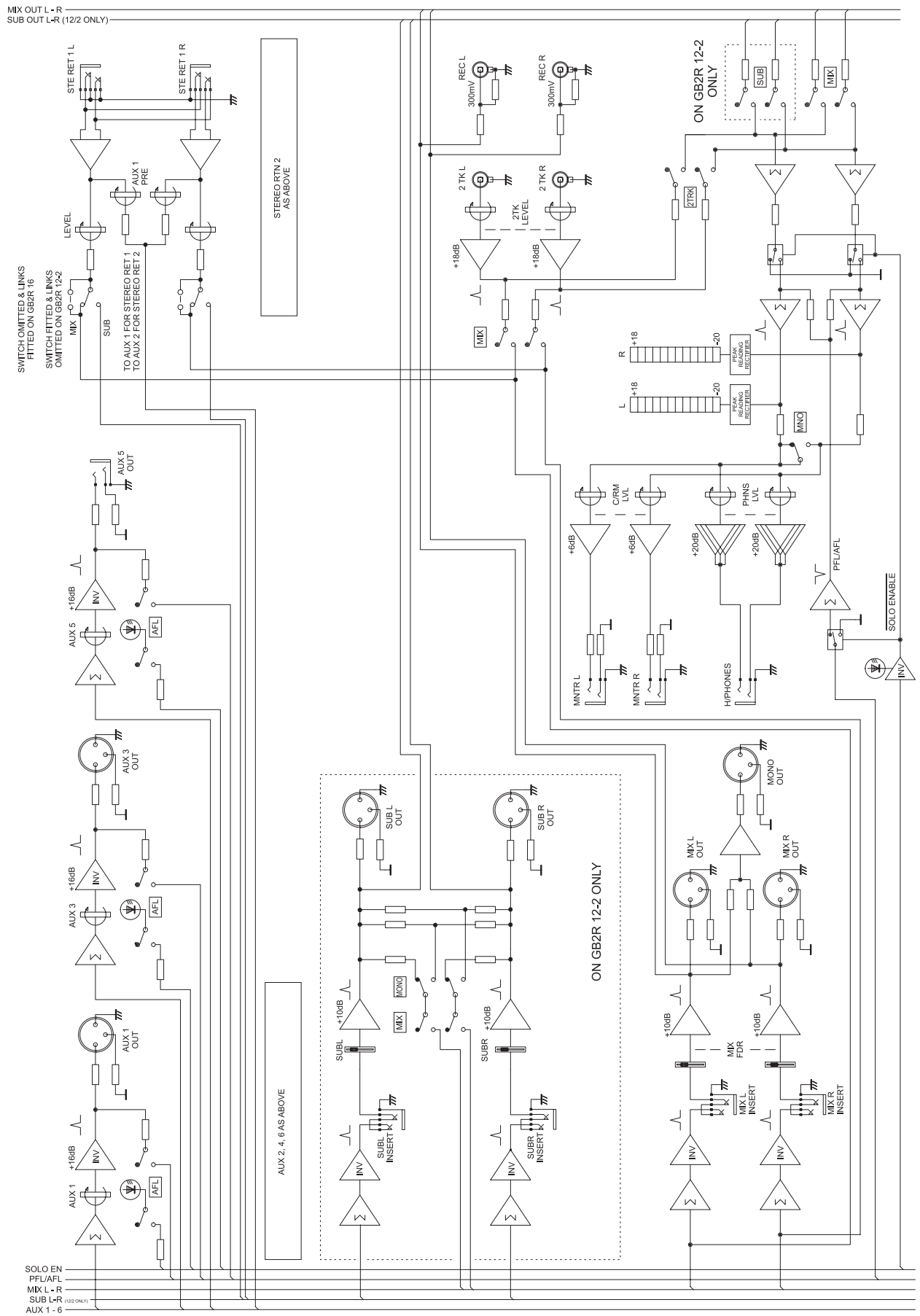

# Using The Console

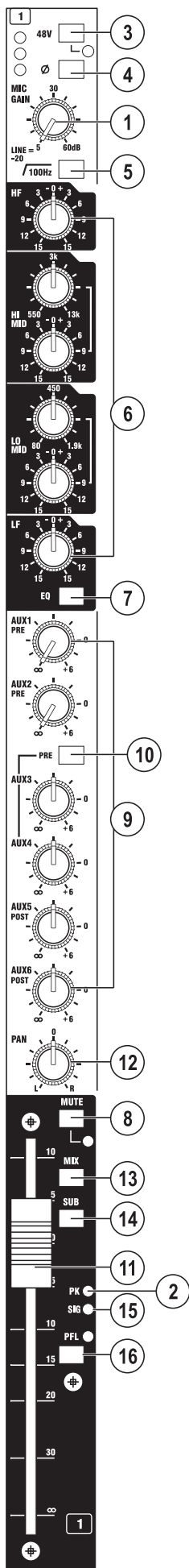

## Mono Input

The MIC GAIN control (1) adjusts the sensitivity of both mic (XLR) and Line (1/4" jack) inputs. Both inputs are electronically balanced, and are located on the rear connector panel.

The PEAK LED (2) monitors two points in the audio path: pre-insert point and post-EQ.



The 48V switch (3) applies 48V phantom power to the input XLR. An adjacent LED indicates when the phantom power is on.

Don't connect microphones with the phantom power switched on.

Only switch the phantom power on or off with the output fader down.

The PHASE switch (4) reverses the phase of the input.

The HI-PASS switch (5) enables the high-pass filter.

The module insert point is pre-EQ, pre-fader. It is located on the rear connector panel.

The EQ section (6) is four band, with shelving HF and LF, and swept peaking high and low mid sections.

The HF and LF sections give +/-15dB cut/boost at 13kHz and 60Hz respectively. The Lo-mid section gives +/-15dB cut/boost at 80Hz-1.9kHz. The Hi-mid section gives +/-15dB cut/boost at 550Hz-13kHz.

The section is switched in by the EQ switch (7).

The signal in the module is turned on and off by the MUTE switch (8). An adjacent LED illuminates when the module is muted. All outputs from the module are muted, except for the Direct Output if its Pre button is depressed. The PFL will still work whilst the module is muted.

Signal is sent to the AUX 1-6 busses via individual level pots (9). Aux 1 and 2 are both post-eq\* pre-fade feeds. Aux 3 and 4 are jointly selectable, via the PRE switch (10) to be pre-fade\* or post-fade feeds. Aux 5 and 6 are post-fade feeds\*.

\* Note: there is a dealer-implemented option to connect aux 1 and 2 feeds as pre-eq pre fade. This would also affect aux 3 and 4 when they are selected as pre-fade.

Aux 5 and 6 may be connected to follow aux3/aux4 pre/post routing. The warranty is voided if these options are implemented by anyone other than an Authorised Soundcraft Dealer.

Post-fader signal level is controlled by a 100mm fader (11).

Signal for the mix and sub (sub applies to GB2R12-2 only) busses are routed via the PAN pot (12). The pan pot positions the signal within the stereo image. The signal can be sent to the stereo mix busses (13) and/or sub busses (14 - GB2R12-2 only). Note that the sub busses are a stereo pair.



Note for GB2R 16 only. At first sight, being able to de-select the feed to the mix busses (13) may seem pointless, but it allows the user to route signal to the aux busses, and/or to use the Direct Outputs post-fade, without routing to the main mix.

A signal LED (15), next to the fader, meters the post-EQ, pre-mute signal.

The PFL switch (16) feeds the pre-mute signal to the monitor outputs and phones output. An adjacent LED indicates when the PFL is on.

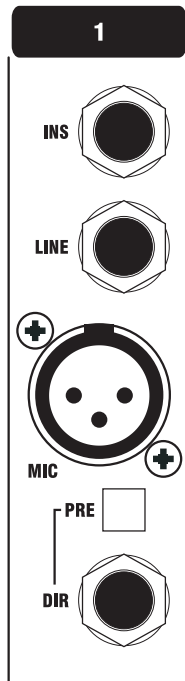

## Rear Connectors

### INSERT (1/4" TRS Jack)

Tip	Send Signal
Ring	Return Signal
Sleeve	Ground

### LINE INPUT (1/4" TRS Jack)

Tip	Signal Hot
Ring	Signal Cold
Sleeve	Ground

### MIC INPUT (3 pin female XLR)

Pin 1	Ground
Pin 2	Signal Hot
Pin 3	Signal Cold

### DIRECT OUTPUT (1/4" TRS Jack)"

Tip	Signal Hot
Ring	Signal Cold
Sleeve	Ground

The DIRECT OUTPUT is normally post fader. Pressing the PRE button switches it to pre-insert-point.

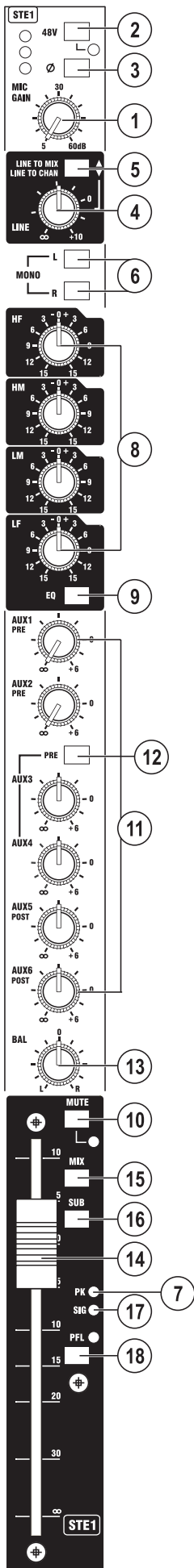

## Stereo Input - GB2R 12-2 only

MIC GAIN (1) adjusts the sensitivity of the stereo pair of mix XLR inputs. They are electronically balanced, and are located on the rear connector panel.



The 48V switch (2) applies 48V phantom power to the input XLRs. An adjacent LED indicates when the phantom power is on.

Don't connect microphones with the phantom power switched on. Only switch the phantom power on or off with the output fader down.

The PHASE switch (3) inverts the phase of the left channel XLR.

The LINE level control (4) adjusts the signal level from the stereo pair of line input 1/4" jacks on the rear connector panel. The line inputs are balanced.

The LINE TO MIX/LINE TO CHAN (5) switch works as follows:



When the switch is in the raised position (LINE TO MIX) the signals from the line inputs are routed (via the line level control) directly to the main mix L & R busses. The XLR mic inputs are routed through the channel. This, in effect, gives an extra stereo return input.

When the switch is in the depressed position (LINE TO CHAN) the signals from the line inputs are routed through the channel. The mic XLR inputs are not used.

The L switch (6) routes the left input signal to both L and R channels in the module. The R switch similarly routes the right input signal. Pressing L and R together mono sums the input.

The PEAK LED (7), monitors both left and right signals pre-EQ.

The EQ section (8) has four bands, with shelving high and low frequencies and peaking high-mid and low-mid bands.

The HF control gives +/-15dB cut/boost at 13KHz. The LF control gives +/-15dB cut/boost at 60Hz. The HM control gives +/-15dB cut/boost at a centre frequency of 2.5kHz, and the LM control gives +/-15dB cut/boost at a centre frequency of 450Hz. The EQ is switched in by the EQ switch (9).

The stereo signal in the module is turned on and off by the MUTE switch (10). An adjacent LED illuminates when the module is muted. The PFL will still work whilst the module is muted. The Line To Mix routing [see (5) above] is not affected by the MUTE switch.

A mono sum of the signal is sent to the AUX 1-6 busses via individual level pots (11). Aux 1 and 2 are both post-eq\* pre-fade feeds. Aux 3 and 4 are jointly selectable, via the PRE switch (12) to be pre-fade\* or post-fade feeds. Aux 5 and 6 are post-fade feeds\*.

\* Note: there is a dealer-implemented option to connect aux 1 and 2 feeds as pre-eq pre fade. This would also affect aux 3 and 4 when they are selected as pre-fade.

Aux 5 and 6 may be connected to follow aux3/aux4 pre/post routing.

The warranty is voided if these options are implemented by anyone other than an Authorised Soundcraft Dealer.

The BAL control (13) allows the stereo image to be balanced between the left and right channels within the module.

Post-fader signal level is controlled by a 100mm stereo fader (14).

The signal can be sent to the stereo mix busses (15) and sub busses (16). Note the sub busses are a stereo pair.

A signal LED (17), next to the fader, meters the post-EQ, pre-mute signal.

The PFL switch (18) feeds a mono sum of the pre-mute signal to the monitor output and phones output. An adjacent LED indicates when the PFL is on.

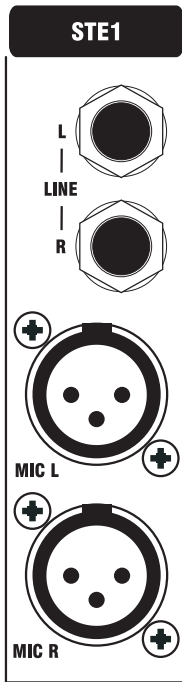

## Rear Connectors

### MIC INPUT LEFT and RIGHT (3 pin female XLR)

Pin 1	Ground
Pin 2	Signal Hot
Pin 3	Signal Cold

### LINE INPUT LEFT and RIGHT (1/4" TRS Jacks)

Tip	Signal Hot
Ring	Signal Cold
Sleeve	Ground

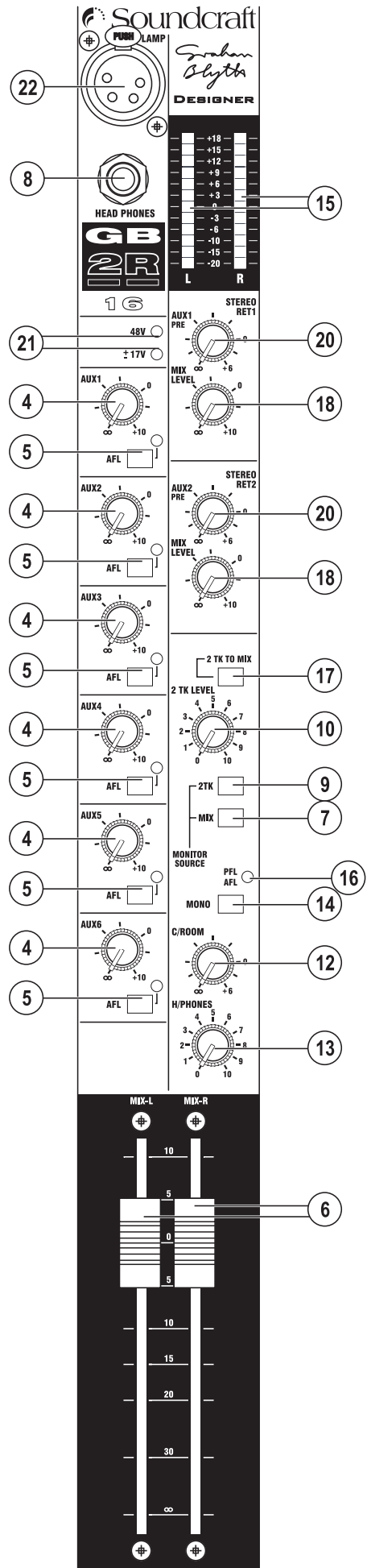
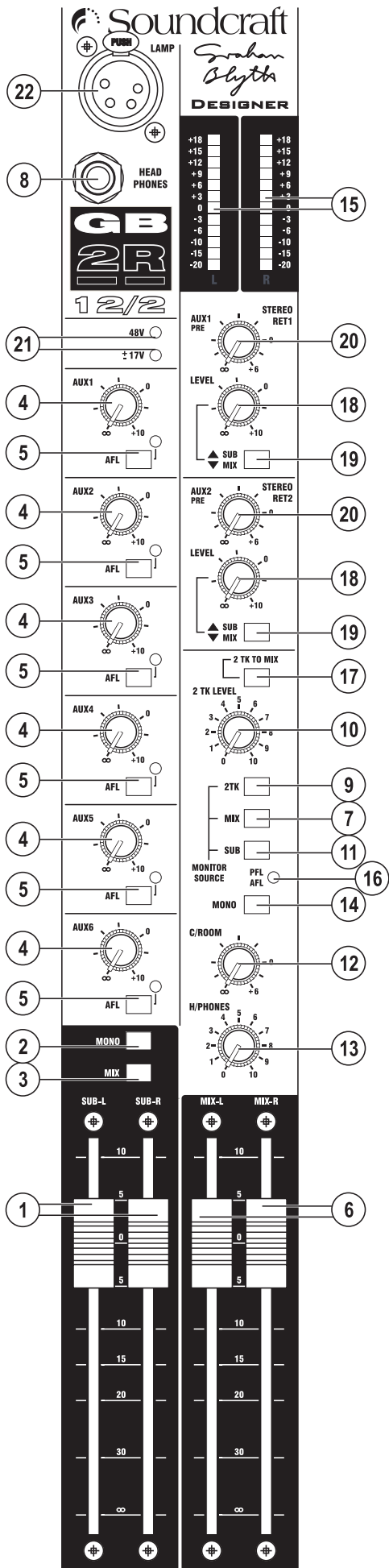

## Master Section

### SUB GROUPS (GB2R 12-2 Only)

There are two Sub groups. They are arranged as a stereo pair.

Each Sub fader (1) is placed after its Sub insert point (on the rear panel). The faders control the signal levels which are then fed to the Sub Output XLRs on the rear connector panel.

The MONO switch (2) creates a mono sum of the sub left and sub right signals. Each post-fader group signal pair can be routed to the main mix stereo pair via the MIX switch (3).

### AUX MASTERS

Each AUX master level pot (4) controls the level fed from its own aux bus to its aux output.

Aux outputs 1-4 are balanced via XLR connectors, aux 5 and 6 outputs are balanced via 3-pole 1/4" jack sockets on the rear connector panel.

Each AFL button (5) feeds its aux post-fader signal to the monitor output and phones output.

### Mix L, R and Mono Outputs

Each of the 2 main mix busses, Left and Right, has its own insert point. These are located on the rear connector panel. Each main mix bus has a Fader (6) which follows the insert point in its signal path.

The post-fader signal for each bus is then routed to the following places:

- its main output XLR on the rear connector panel,
- the REC output sockets on the rear connector panel,
- the MONITOR SOURCE select switch MIX (7).

A mono sum of the L & R outputs is available on the MONO output XLR on the rear connector panel.

### Record Outputs

The REC outputs are via a stereo pair of RCA phono sockets on the rear connector. They carry the same signals as the Mix L and Mix R outputs.

### Monitoring & PFL/AFL

The monitor section feeds the Monitor L & R outputs (3-pole 1/4" balanced jack sockets on the rear connector panel) and the headphones output (8).

The sources for the monitor section are:

- the 2-track input (9), its volume is controlled by the 2-TRK LEVEL control (10),
- the sub groups (11)(GB2R 12-2 only), and
- the main mix (7).

Any or all of these sources may be selected at any one time. The monitor signals (L & R) are passed to the monitor L & R outputs via the C/ROOM level pot (12), and to the headphones socket via the H/PHONES pot (13). The monitor L & R signals can be mono summed using the MONO switch (14).

The L & R 12-segment meters (15) indicate the level of the monitored signal, as selected by the monitor source select switches.

When any PFL or AFL button is pressed the meters display the pfl/af1 signal

level, and the pfl/afl signal is routed to the control room outputs and to the headphones. This signal replaces the normal monitor signal. The PFL/AFL LED (16) illuminates when this is happening.

Note: the 2-track input may also be routed directly to the main L-R mix via the 2 TRK TO MIX switch (17).

### **Stereo Returns**

There are two stereo returns. Each one is fed from a pair of 1/4" jacks on the rear connector panel. The inputs are electronically balanced. The stereo signal is routed, via the LEVEL pot (18) to the Main Mix or the Sub groups via the MIX/SUB switch (19)(GB2R 12-2 only, the GB2R 16 routes the signal to the main mix busses).

A pre-level-control mono-sum of the input pair is routed, via the Aux 1 (or Aux2) pot (20) to the Aux 1 or Aux 2 bus respectively.

### **PSU Monitor LEDs**

These LEDs (21) confirm the presence of the correct voltage on the +48V and the +/-17V power rails in the console.

### **Lamp**

The 4-pin socket on the fascia, which is marked 'LAMP' (22), can be used for a range of commercially-available gooseneck lamps. The socket provides a 12V supply.

## **Front Panel Connectors**

H/PHONES (1/4" TRS Jacks)

Tip	Left Signal
Ring	Right Signal
Sleeve	Ground

LAMP (4-pin XLR)

Pin 1	No Contact
Pin 2	No Contact
Pin 3	Lamp Shell
Pin 4	Lamp Centre Contact



## Rear Connector Panel

### MIX L, R & MONO OUTPUTS (3-pin male XLRs)

Pin 1	Ground
Pin 2	Signal Hot
Pin 3	Signal Cold

### MIX L & R INSERT POINTS (1/4" TRS Jacks)

Tip	Send Signal
Ring	Return Signal
Sleeve	Ground

### L & R MONITOR OUTPUTS (1/4" TRS Jacks)

Tip	Signal Hot
Ring	Signal Cold
Sleeve	Ground

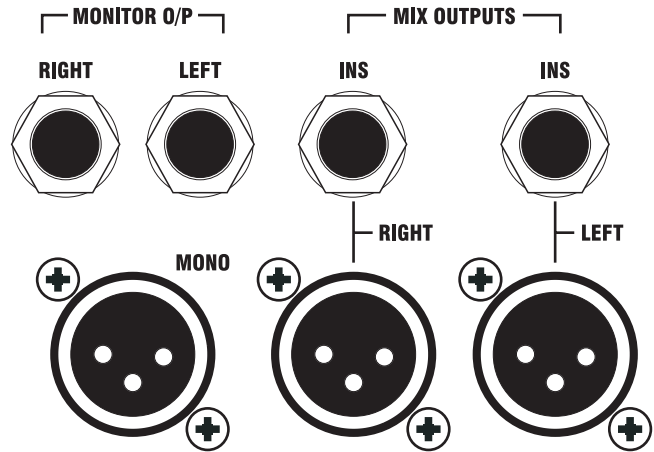

### SUB L & R OUTPUTS (3-pin male XLRs)

#### GB12R 12/2 ONLY

Pin 1	Ground
Pin 2	Signal Hot
Pin 3	Signal Cold

### SUB L & R INSERT POINTS (1/4" TRS Jacks)

#### GB12R 12/2 ONLY

Tip	Send Signal
Ring	Return Signal
Sleeve	Ground

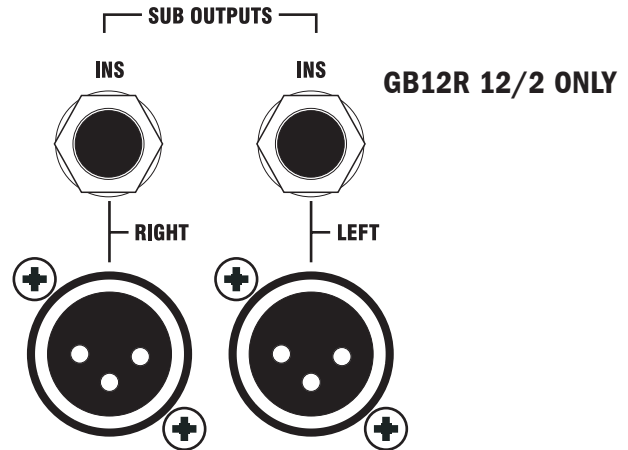

### AUX 1-4 OUTPUTS (3-pin male XLRs)

Pin 1	Ground
Pin 2	Signal Hot
Pin 3	Signal Cold

### AUX 5-6 OUTPUTS (1/4" TRS Jacks)

Tip	Signal Hot
Ring	Signal Cold
Sleeve	Ground

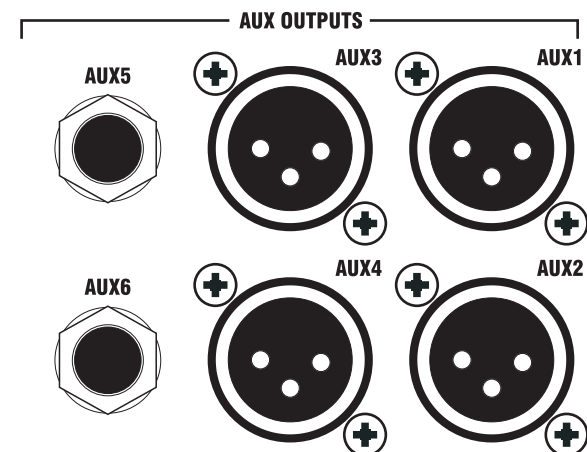

REC OUTPUTS (RCA Phonos)  
 Centre      Signal  
 Screen      Ground



2-TRACK INPUTS (RCA Phono)  
 Centre      Signal  
 Screen      Ground



STEREO RETURNS INPUTS (1/4" TRS Jacks)  
 Tip            Signal Hot  
 Ring          Signal Cold  
 Sleeve        Ground

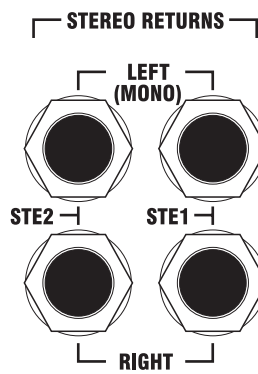

# Typical Specifications

## Frequency Response

Mic/Line Input to any output, 20Hz - 20kHz <1dB

## THD + N

Mic sens. -30dBu, +10dBu at all outputs @1kHz <0.006%

## Noise

Measured RMS, 22Hz to 22kHz Bandwidth

Mic E.I.N. @ unity gain, 1500ohm source impedance -128dBu

Mix Output, 16 inputs routed to mix <-86dBu

Group & Centre Outputs <-86dBu

Aux Outputs <-86dBu

## Crosstalk (@1kHz, typical)

Input Channel Mute <-97dB

Input Fader cut-off <-95dB

Pan isolation <-77dB

Mix route isolation <-97dB

Group route isolation <-97dB

Adjacent channel crosstalk <-99dB

Group to Mix <-89dB

Aux Send pots offness (typical) <-84dB

## CMRR

Typical @ 1kHz 90dB

## Input & Output Max Levels

Mono & Stereo Mic Inputs +15dBu

Mono & Stereo Line Inputs +30dBu

Stereo Returns & Insert Returns +20dBu

Any output +20dBu

Nominal Operating Level 0dBu

Headphone Power 2 x 250mW into 2000ohms

## Input & Output Impedances

Mic Inputs 2kOhms

Line Inputs and Stereo Returns 10kOhms

Input channels Insert Return 5kOhms with EQ in, otherwise 3kOhms

Mix, Group, Aux, Matrix & Direct outputs 150ohms

Insert sends 75ohms

Recommended Headphone Impedance 50-600ohms

## EQ (Mono input)

High pass filter (Mono input) 100Hz, 18dB/octave

HF 13kHz, +/-15dB, 2nd order shelving

Hi-Mid 550Hz-13kHz, +/-15dB, Q=1.5

Lo-Mid 80Hz-1.9kHz, +/-15dB, Q=1.5

LF 80Hz, +/-15dB, 2nd order shelving

## Metering

Input channels Single LEDs, Signal Present & Peak

Outputs 2 tri-colour 12-segment LED bargraphs

## Power

AC mains supply (internal PSU) 90V-240V AC, 50/60Hz universal input

Power consumption Less than 100W

## Operating conditions

Temperature range -10°C to +30°C

Relative humidity 0% to 80%

Note: These figures are typical of performance in a normal electromagnetic environment. Performance may be degraded in severe conditions. All measurements refer to electronically balanced inputs and outputs.

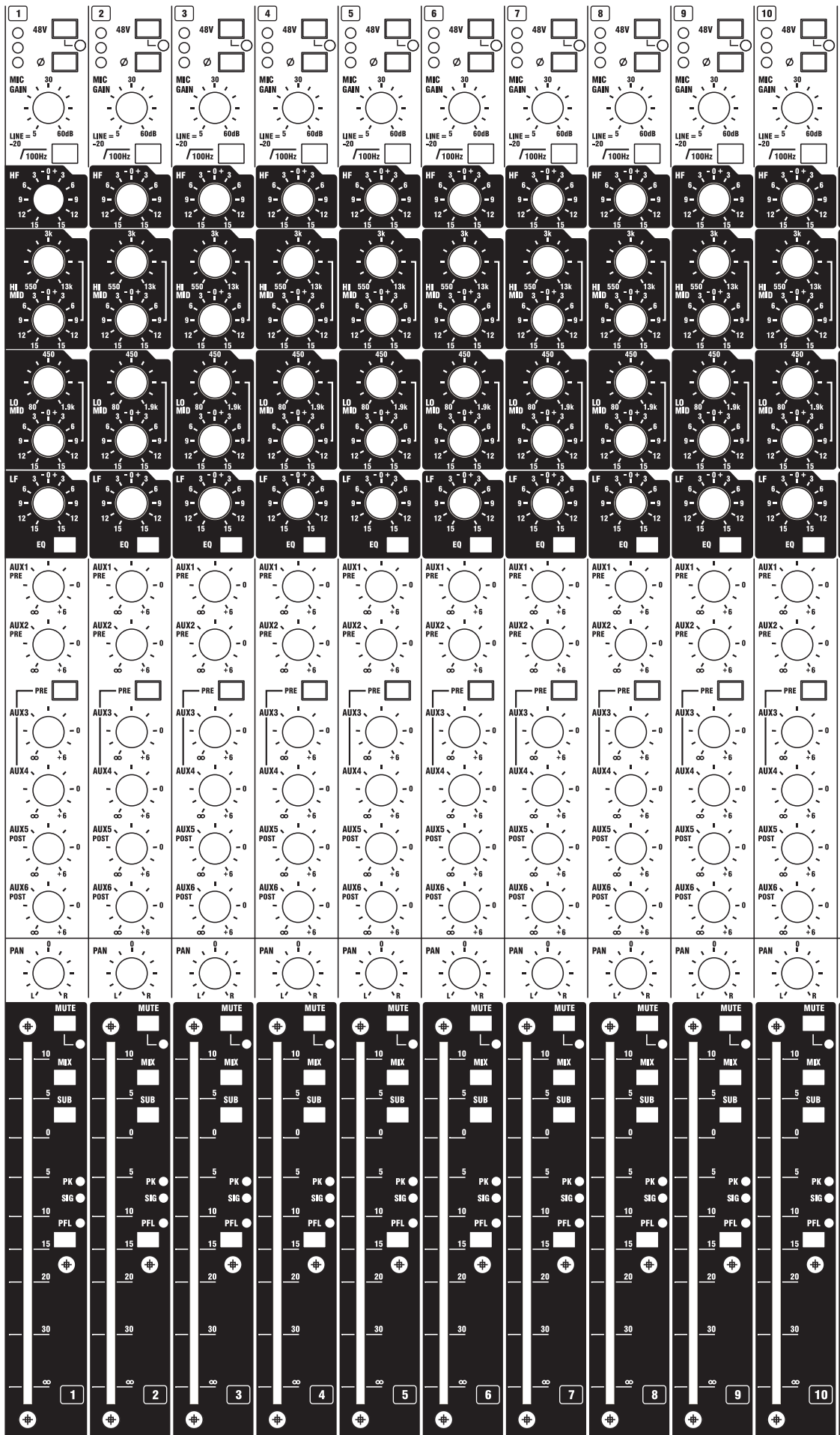

# GB2R 12/2 Mark-up Sheet

You may wish to photocopy these pages to record settings for gigs.



	11	12	STE1	STE2
MIC GAIN				
LINE TO MIX				
LINE TO CHAN				
HF				
HI MID				
LO MID				
LF				
EQ	<input type="checkbox"/>	<input type="checkbox"/>	<input type="checkbox"/>	<input type="checkbox"/>
AUX1 PRE				
AUX2 PRE				
AUX3 PRE				
AUX4 PRE				
AUX5 POST				
AUX6 POST				
PAN				
MUTE	<input type="checkbox"/>	<input type="checkbox"/>	<input type="checkbox"/>	<input type="checkbox"/>

**GB 2R**  
**12/2**

**Soundcraft**  
*Shaham Slytha*  
**DESIGNER**

48V

±17V

AUX1 AFL

AUX2 AFL

AUX3 AFL

AUX4 AFL

AUX5 AFL

AUX6 AFL

MONO

MIX

LAMP

HEAD PHONES

STEREO RET1

STEREO RET2

2 TK TO MIX

2 TK LEVEL

2TK

MIX

SUB

MONITOR SOURCE

PFL AFL

MONO

C/ROOM

H/PHONES

MONO

MIX

11

12

STE1

STE2

MONO

MIX

SUB-L

SUB-R

MIX-L

MIX-R

GB2R User Guide

29

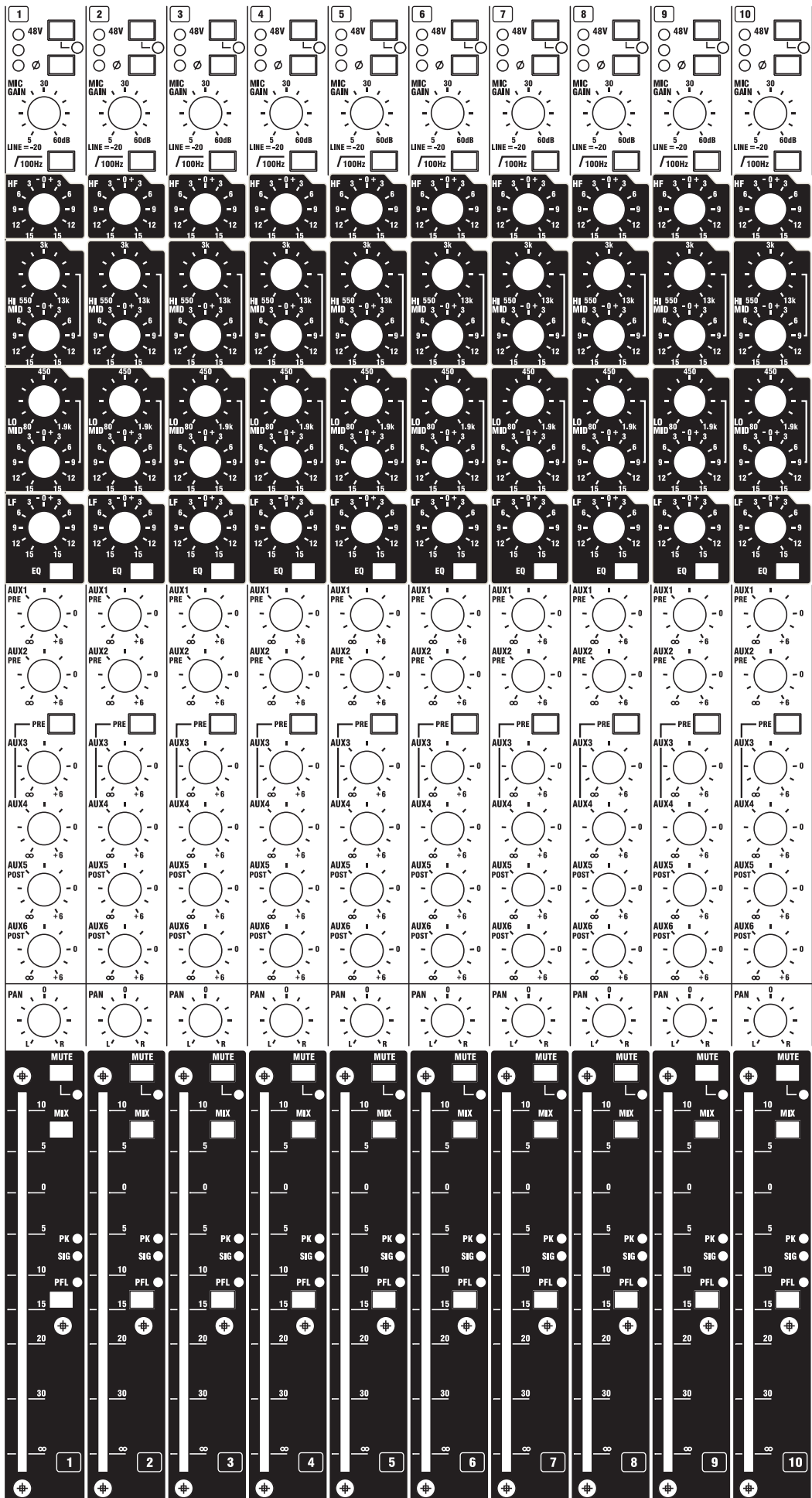

# GB2R 16 Mark-up Sheet



You may wish to photocopy these pages to record settings for gigs.

11	12	13	14	15	16
MIC GAIN 48V MIC 30 LINE -20 60dB 100Hz	MIC GAIN 48V MIC 30 LINE -20 60dB 100Hz	MIC GAIN 48V MIC 30 LINE -20 60dB 100Hz	MIC GAIN 48V MIC 30 LINE -20 60dB 100Hz	MIC GAIN 48V MIC 30 LINE -20 60dB 100Hz	MIC GAIN 48V MIC 30 LINE -20 60dB 100Hz
HF 3 -0+3 6 9 12 15	HF 3 -0+3 6 9 12 15	HF 3 -0+3 6 9 12 15	HF 3 -0+3 6 9 12 15	HF 3 -0+3 6 9 12 15	HF 3 -0+3 6 9 12 15
HI 550 MID 3 -0+3 6 9 12 15	HI 550 MID 3 -0+3 6 9 12 15	HI 550 MID 3 -0+3 6 9 12 15	HI 550 MID 3 -0+3 6 9 12 15	HI 550 MID 3 -0+3 6 9 12 15	HI 550 MID 3 -0+3 6 9 12 15
LO 450 MID 80 3 -0+3 6 9 12 15	LO 450 MID 80 3 -0+3 6 9 12 15	LO 450 MID 80 3 -0+3 6 9 12 15	LO 450 MID 80 3 -0+3 6 9 12 15	LO 450 MID 80 3 -0+3 6 9 12 15	LO 450 MID 80 3 -0+3 6 9 12 15
LF 3 -0+3 6 9 12 15	LF 3 -0+3 6 9 12 15	LF 3 -0+3 6 9 12 15	LF 3 -0+3 6 9 12 15	LF 3 -0+3 6 9 12 15	LF 3 -0+3 6 9 12 15
EQ	EQ	EQ	EQ	EQ	EQ
AUX1 PRE AUX2 PRE	AUX1 PRE AUX2 PRE	AUX1 PRE AUX2 PRE	AUX1 PRE AUX2 PRE	AUX1 PRE AUX2 PRE	AUX1 PRE AUX2 PRE
AUX3 PRE AUX4 PRE	AUX3 PRE AUX4 PRE	AUX3 PRE AUX4 PRE	AUX3 PRE AUX4 PRE	AUX3 PRE AUX4 PRE	AUX3 PRE AUX4 PRE
AUX5 POST AUX6 POST	AUX5 POST AUX6 POST	AUX5 POST AUX6 POST	AUX5 POST AUX6 POST	AUX5 POST AUX6 POST	AUX5 POST AUX6 POST
PAN L R	PAN L R	PAN L R	PAN L R	PAN L R	PAN L R

DESIGNER

HEAD PHONES

16

48V

±17V

AUX1

AUX2

AUX3

AUX4

AUX5

AUX6

MONITOR SOURCE

2 TK TO MIX

2 TK LEVEL

MIX

MONO

C/ROOM

H/PHONES

STEREO RET1

MIX LEVEL

STEREO RET2

MIX LEVEL

2 TK

MIX

MONO

C/ROOM

H/PHONES

MUTE	MUTE	MUTE	MUTE	MUTE	MUTE	MIX-L	MIX-R
10 5 0	10 5 0	10 5 0	10 5 0	10 5 0	10 5 0	10 5 0	10 5 0
PK	PK	PK	PK	PK	PK		
SIG	SIG	SIG	SIG	SIG	SIG		
PFL	PFL	PFL	PFL	PFL	PFL		
15 20	15 20	15 20	15 20	15 20	15 20	15 20	15 20
30	30	30	30	30	30	30	30
∞	∞	∞	∞	∞	∞	∞	∞
11	12	13	14	15	16		

# Dimensions

## Free Standing

Top View  
441.00mm

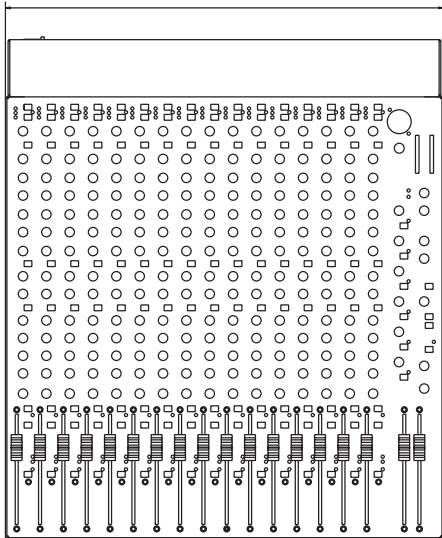

Side View  
534.79mm

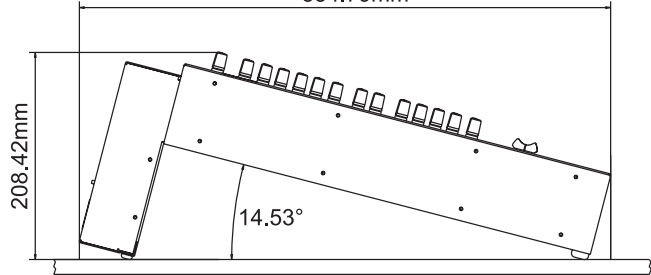

Rear View

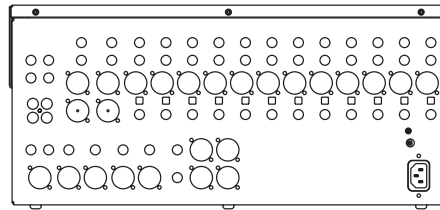

## Rack Mounted

Top View  
482.60mm

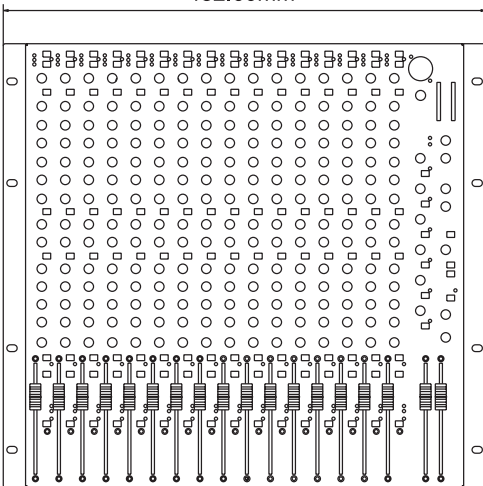

Side View  
443.70mm

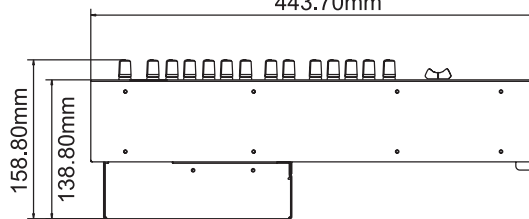

Rear View

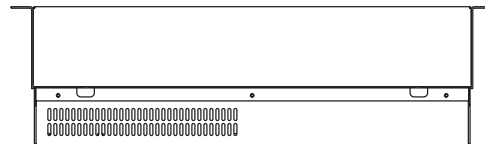



# Rack Mounting

## Instructions

Remove the mains and all other connections before starting.

There are 5 diagrams ( A-E).

Follow the instructions in numerical order (1-8 on diagram B, 9-11 on diagram C etc).

Note that all the screws are re-used. There should be no screws left over at the end of the procedure.

The parts' new destinations are shown in rectangles on the diagrams, e.g. C:10 on diagram B: instruction 8 shows a screw being removed. This screw is then re-used in diagram C at instruction 10.

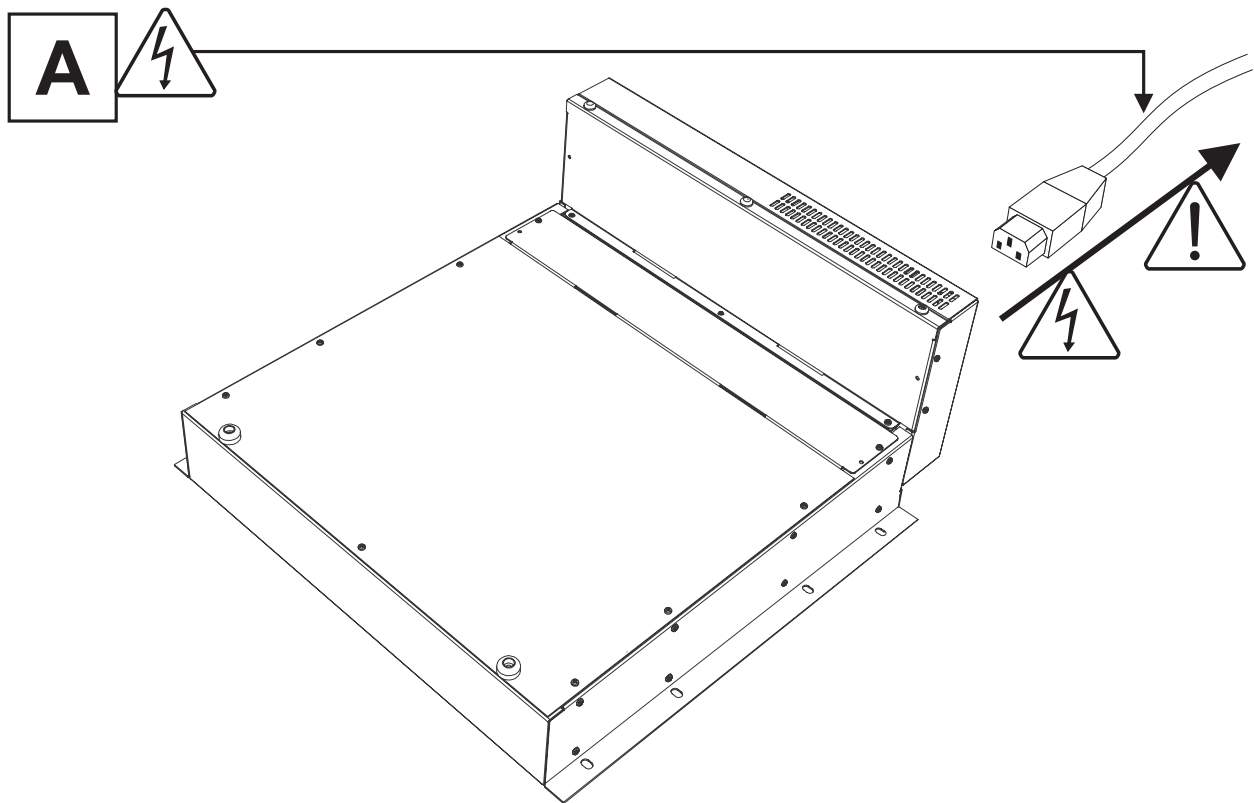

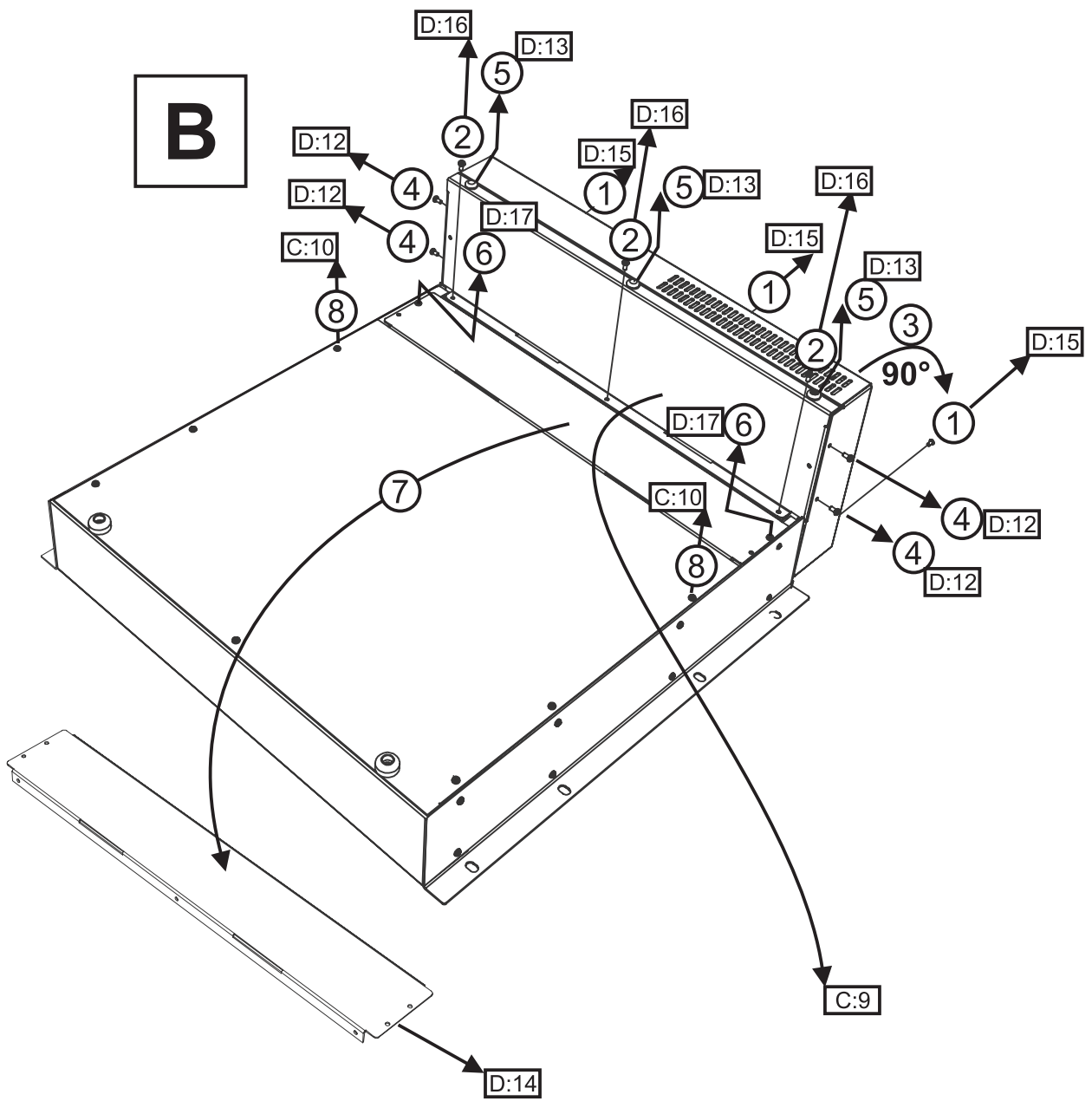

**C**

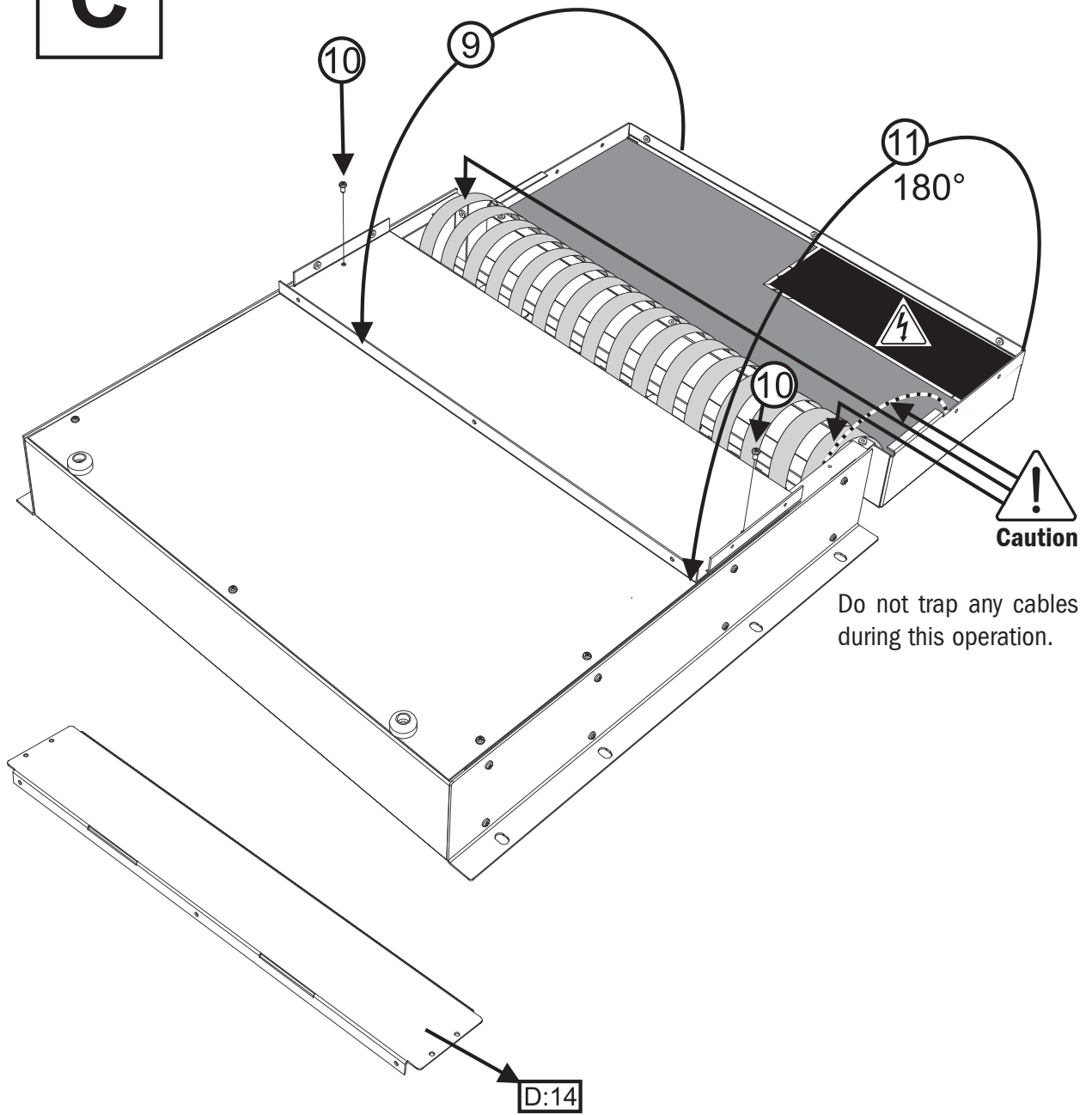

**D**

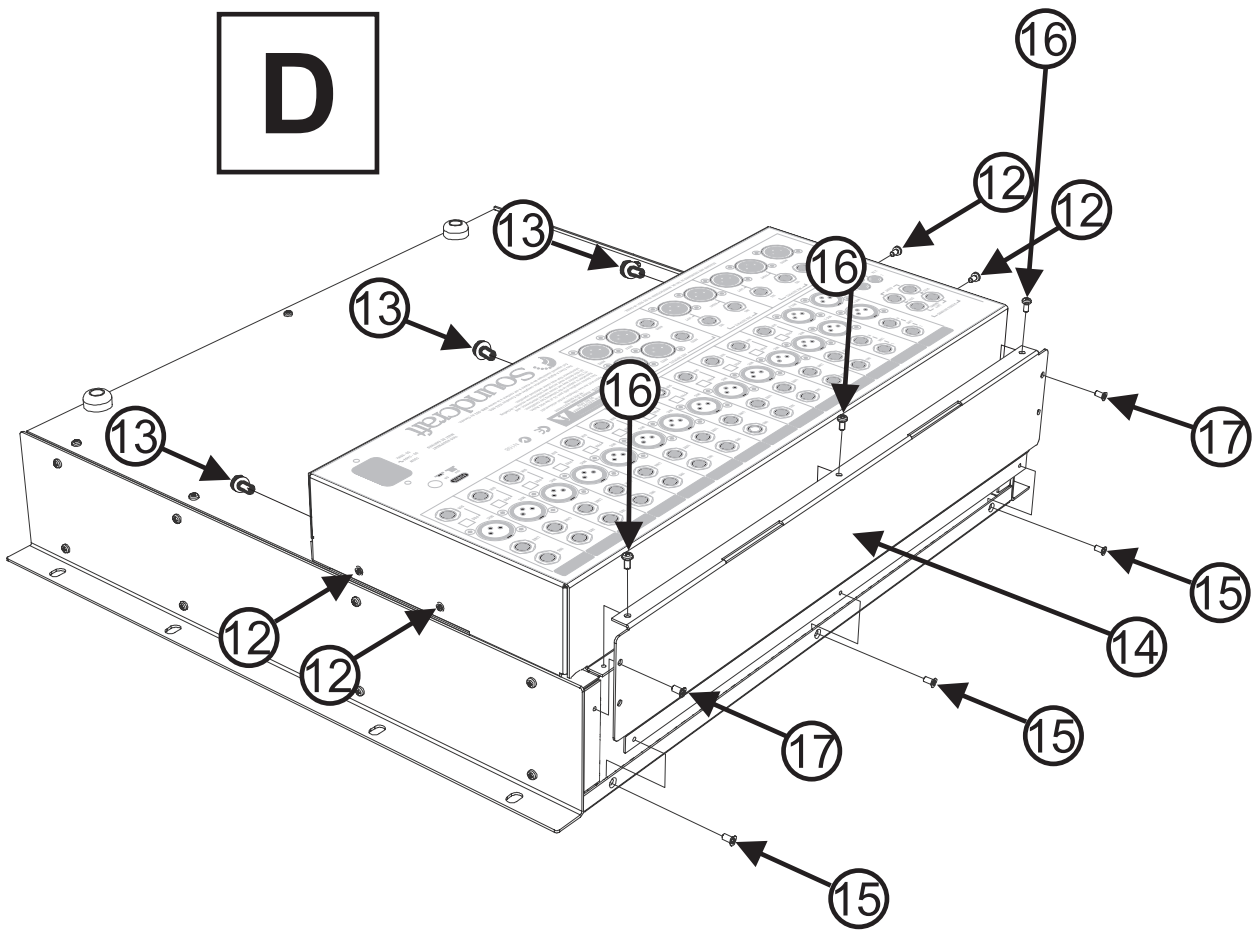

**E**

